



LOOB

Stainless steel

STRAPPING BANDS AND ACCESSORIES



CONTENTS

ABOUT US	3
STRAPPING BANDS	5
└ Stainless steel band - grade 1.4016 / AISI 430	6
└ Stainless steel band - grade 201	8
└ Stainless steel band - grade 1.4301 / AISI 304	10
└ Stainless steel band - grade 1.4404 / AISI 316l	12
└ Stainless steel banding buckles - for strapping bands: steel grade: AISI 304, 201	14
└ XL stainless steel band - grade 1.4301 / AISI 304	15
└ Stainless steel banding buckles - for XL strapping band; steel grade: AISI 304	17
└ Screw banding tool	18
└ Ratchet banding tool	19
└ Plastic dispenser	20
└ Protective rubber band	21
└ Stainless steel worm drive clamp band - steel grade: AISI 304, AISI 430	22
└ Fixing buckles for worm drive clamp bands - steel grade: AISI 304, AISI 430	23
BALL-LOCK CABLE TIES	24
└ Cable ties Ball-lock type	25
└ Steel tie crimper Ball-lock type	26
└ Ball-lock tie tensioner	27
ROAD CONSTRUCTION PRODUCTS	28
└ Traffic sign holder - type: edge	29
└ Traffic sign holder - Type: universal (wave)	30
└ Auger - holder for emergency signage	31
└ Mounting sleeve - for road signs	32
POWER INDUSTRY PRODUCTS	33
└ Label plates	34
DISTRIBUTION	35



EXPERIENCED STAFF IS A RELIABLE PARTNER IN BUSINESS.

Our technical expertise and qualifications will help you to choose the right products. The potential of the possibilities and scope of activities allows to adjust the materials to individual customer needs. Our solutions are successfully used in many sectors of the industry.

Specialists with an excellent knowledge of corrosion-resistant bands and all their types are at your disposal and will be happy to answer any technical questions. We also offer attractive forms of financing and beneficial logistics solutions for our customers.



OUR STRENGTHS



PROFESSIONAL SERVICE

Properly identified needs and selection of individual solutions help to meet the requirements of our customers.



SHORT LEAD TIMES

Short order completion time is a result of dynamically operating, integrated company departments.



COMPETITIVE PRICING

We make every effort to make our prices attractive to our customers through the flexibility of selected solutions.



HIGHEST REPEATABLE QUALITY OF OFFERED PRODUCTS

We are an acknowledged supplier of stainless steel materials. We owe our reputation to meeting the requirements of a wide range of industries in our business area.



TIMELY DELIVERIES

The obligations of our customers are our priority. That is why we set punctuality of deliveries as one of our main goals.



LOW VOLUME DELIVERIES POSSIBILITY

Retail customers are very important to our company and their satisfaction is a testament to our quality.



TECHNICAL CONSULTING

Our sales department is made up of experts who specialise in stainless steel and acid-resistant steel bands – they will provide comprehensive material advice.



POSSIBILITY OF CUSTOM-TAILORED SOLUTIONS

Non-standard dimensions and materials are a challenge which we are willing to take up in order to provide our customers with material that is difficult to access (classified as not available on the market).



STRAPPING BANDS

STAINLESS STEEL BAND

GRADE 1.4016 / AISI 430



Standard: **EN 10088-2**

Edges: **rounded**

Installation of cables, ventilation ducts, masts, poles, road signs; suspension of additional equipment for cable ducts, process piping, poles; packing for transport, bundling of steel and plastic pipes, installation of flexible pipe connections, and many others. Elements used in moderate corrosive environments.

MATERIAL CHARACTERISTICS:



MODERATE MECHANICAL STRENGTH



RESISTANT TO OXIDATION AT HIGH TEMPERATURES



RESISTANCE TO LOW TEMPERATURES



THERMAL EXPANSION LOWER THAN AUSTENITIC GRADES



SMOOTH FINISH ON ALL SURFACES



USE

Interior architectural applications, elements used in air-conditioned rooms. Construction applications in moderate corrosive environments. Components operating at high temperature change gradient, exposed to strong oxidation at high temperatures. Applications for agriculture, transport applications.



STRAPPING BAND SIZE CHART

Width [mm]	Thickness [mm]	Roll weight [kg]		
		50 m roll	30 m roll	25 m roll
19	0,7	5,2	3,1	2,6
16	0,7	4,4	2,6	2,2
12,7	0,7	3,5	2,1	1,7
9,5	0,6	2,2	1,3	1,1
6,4	0,5	1,3	0,8	0,6
20	0,7	5,5	3,3	2,7
10	0,7	2,8	1,7	1,4
20	0,4	3,1	1,9	1,6
10	0,4	1,6	0,9	0,8



CHEMICAL COMPOSITION

Grade	Element, % (max.)*								
	C	Si	P	S	Mn	Cr	Ni	Mo	N
1.4016	0,08	1,0	0,040	0,015	1,0	16,0 - 18,0	-	-	-

* Range of the concentrations of elements meeting the requirements of EN 10088-2

MECHANICAL AND ELECTRICAL PROPERTIES

Grade	Mechanical properties *					Electrical properties	
	Tensile strength	Yield strength, min	Elongation, min	Hardness, max		Magnetic permeability	Electrical resistance at 20°C
	R _m , MPa	R _{p0,2} , MPa	A ₈₀ , %	HBW	HRB	μ	Ωmm ² /m
1.4016	450 - 600	260	20	183	89	600 - 1100	0,60

* Range of the mechanical properties meeting the requirements of EN 10088-2 in saturated state

RELATED PRODUCTS

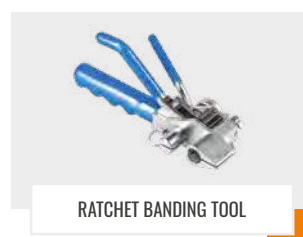
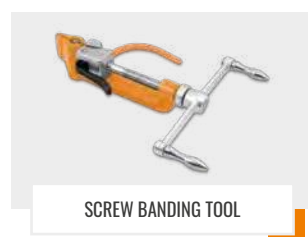
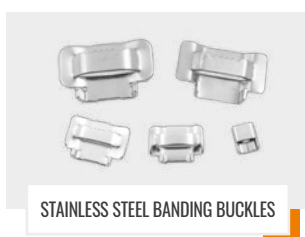



Standard: **ASTM A 240**

Edges: **rounded**

Installation of cables, ventilation ducts, masts, poles, road signs; suspension of additional equipment for cable ducts, process piping, poles; packing for transport, bundling of steel and plastic pipes, installation of flexible pipe connections, and many others. Elements used in moderate corrosive environments.

MATERIAL CHARACTERISTICS:



CORROSION RESISTANCE IN MODERATE AND MILD ENVIRONMENTS



VERY HIGH MECHANICAL STRENGTH



HIGH MECHANICAL PROPERTIES FOR EASY CLAMPING WITHOUT LOSS OF MATERIAL



RESISTANT TO OXIDATION AT HIGH TEMPERATURES



RESISTANCE TO LOW TEMPERATURES



SMOOTH FINISH ON ALL SURFACES



USE

Urban and industrial environment with moderate pollution. Internal and external locations with moderate to mild exposure to chlorides. Urban architecture, steel structures, means of transport. Telecommunication masts and electricity transmission network structures. Coal mining industry. Underground structures, road tunnels, underground infrastructure for telecommunications. Food industry plants.



STRAPPING BAND SIZE CHART

Width [mm]	Thickness [mm]	Roll weight [kg]		
		50 m roll	30 m roll	25 m roll
19	0,7	5,2	3,1	2,6
16	0,7	4,4	2,6	2,2
12,7	0,7	3,5	2,1	1,7
9,5	0,6	2,2	1,3	1,1
6,4	0,5	1,3	0,8	0,6
20	0,7	5,5	3,3	2,7
10	0,7	2,8	1,7	1,4
20	0,4	3,1	1,9	1,6
10	0,4	1,6	0,9	0,8



CHEMICAL COMPOSITION

Grade	Pierwiastek, % (max.)*								
	C	Si	P	S	Mn	Cr	Ni	Mo	N
201	0,15	1,0	0,06	0,03	8,5-11,0	13,0-15,0	1,0-2,0	0,25	1,0

* Range of the concentrations of elements meeting the requirements for steel grade 201 acc. to ASTM A 240

MECHANICAL AND ELECTRICAL PROPERTIES

Grade	Mechanical properties *					Electrical properties	
	Tensile strength	Yield strength, min	Elongation, min	Hardness, max		Magnetic permeability	Electrical resistance at 20°C
	R _m , MPa	R _{p0,2} , MPa	A ₈₀ , %	HBW	HRB	μ	Ωxmm ² /m
201	600-950	260	40	276	105	1,02	0,70

* Range of mechanical properties meeting the requirements for steel grade 201 acc. to ASTM A 240 in saturated state

RELATED PRODUCTS

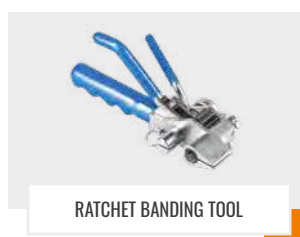
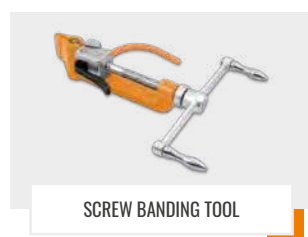

STAINLESS STEEL BAND

GRADE 1.4301 / AISI 304



Standard: **EN 10088-2**

Edges: **rounded**

Installation of cables, ventilation ducts, masts, poles, road signs; suspension of additional equipment for cable ducts, process piping, poles; packing for transport, bundling of steel and plastic pipes, installation of flexible pipe connections, and many others. Elements used in moderate corrosive environments.

MATERIAL CHARACTERISTICS:



CORROSION RESISTANCE IN MODERATE AND MILD ENVIRONMENTS



HIGH MECHANICAL STRENGTH



OPTIMAL COMBINATION OF CORROSION RESISTANCE AND MECHANICAL PROPERTIES



RESISTANT TO OXIDATION AT HIGH TEMPERATURES



RESISTANCE TO LOW TEMPERATURES



SMOOTH FINISH ON ALL SURFACES



USE

Urban and industrial environment with moderate pollution. Indoor and outdoor locations exposed to the presence of chlorides. Chemical and food industry plants, hospital buildings. Telecommunication masts and electricity transmission network structures. Coal mining industry in areas exposed to the presence of chlorides. Underground structures, road tunnels, underground infrastructure for telecommunications.



STRAPPING BAND SIZE CHART

Width [mm]	Thickness [mm]	Roll weight [kg]		
		50 m roll	30 m roll	25 m roll
19	0,7	5,2	3,1	2,6
16	0,7	4,4	2,6	2,2
12,7	0,7	3,5	2,1	1,7
9,5	0,6	2,2	1,3	1,1
6,4	0,5	1,3	0,8	0,6
20	0,7	5,5	3,3	2,7
10	0,7	2,8	1,7	1,4
20	0,4	3,1	1,9	1,6
10	0,4	1,6	0,9	0,8



CHEMICAL COMPOSITION

Grade	Element, % (max.)*								
	C	Si	P	S	Mn	Cr	Ni	Mo	N
1.4301	0,07	0,75	0,045	0,015	2,0	17,5 - 19,5	8,0 - 10,5	-	0,1

* Range of the concentrations of elements meeting the requirements of EN 10088-2

MECHANICAL AND ELECTRICAL PROPERTIES

Grade	Mechanical properties *					Electrical properties	
	Tensile strength	Yield strength, min	Elongation, min	Hardness, max		Magnetic permeability	Electrical resistance at 20°C
	R _m , MPa	R _{p0,2} , MPa	A ₈₀ , %	HBW	HRB	μ	Ωxmm ² /m
1.4301	540 - 740	230	45	201	92	1,008	0,73

* Range of the mechanical properties meeting the requirements of EN 10088-2 in saturated state

RELATED PRODUCTS

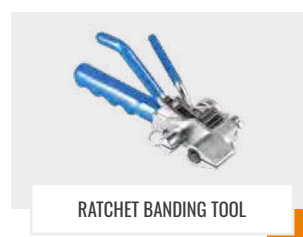
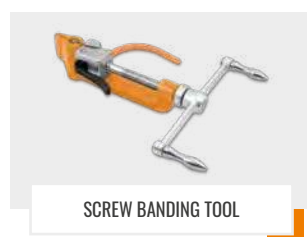
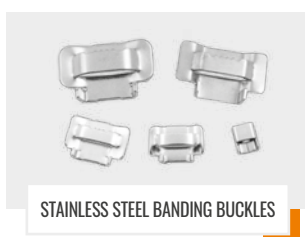

STAINLESS STEEL BAND

GRADE 1.4404 / AISI 316L



Standard: **EN 10088-2**

Edges: **rounded**

Installation of cables, ventilation ducts, masts, poles, road signs; suspension of additional equipment for cable ducts, process piping, poles; packing for transport, bundling of steel and plastic pipes, installation of flexible pipe connections, and many others. Elements used in very aggressive corrosive environments. Indoor and outdoor locations with high humidity and presence of chlorides.

MATERIAL CHARACTERISTICS:



HIGH MECHANICAL STRENGTH



MEETS THE REQUIREMENTS FOR THE MOST DEMANDING WORK ENVIRONMENTS



RESISTANT TO OXIDATION AT HIGH TEMPERATURES



RESISTANCE TO LOW TEMPERATURES



SMOOTH FINISH ON ALL SURFACES



USE

Marine and coastal environments. Marine equipment. Highly polluted urban and industrial environment. Direct location of roads where road salt is used. Elements protected from natural washing by rainfall. Plants with high emission of pollutants, chemical, petrochemical, pulp and paper as well as textile industries.

Coal and copper ore mining industry in areas exposed to the presence of chlorides. Areas exposed to combustion gases containing sulphates. Underground structures, road tunnels.



STRAPPING BAND SIZE CHART

Width [mm]	Thickness [mm]	Roll weight [kg]		
		50 m roll	30 m roll	25 m roll
19	0,7	5,2	3,1	2,6
16	0,7	4,4	2,6	2,2
12,7	0,7	3,5	2,1	1,7
9,5	0,6	2,2	1,3	1,1
6,4	0,5	1,3	0,8	0,6
20	0,7	5,5	3,3	2,7
10	0,7	2,8	1,7	1,4
20	0,4	3,1	1,9	1,6
10	0,4	1,6	0,9	0,8



CHEMICAL COMPOSITION

Grade	Element, % (max.)*								
	C	Si	P	S	Mn	Cr	Ni	Mo	N
1.4401	0,07	0,75	0,045	0,015	2,0	16,5 - 18,0	10,0 - 13,0	2,0 - 2,5	0,1

* Range of the concentrations of elements meeting the requirements of EN 10088-2

MECHANICAL AND ELECTRICAL PROPERTIES

Grade	Mechanical properties *					Electrical properties	
	Tensile strength	Yield strength, min	Elongation, min	Hardness, max		Magnetic permeability	Electrical resistance at 20°C
	R _m , MPa	R _{p0,2} , MPa	A ₈₀ , %	HBW	HRB	μ	Ωxmm ² /m
1.4401	530 - 680	240	40	217	95	1,008	0,75

* Range of the mechanical properties meeting the requirements of EN 10088-2 in saturated state

RELATED PRODUCTS

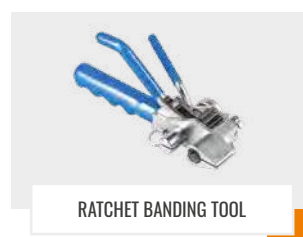
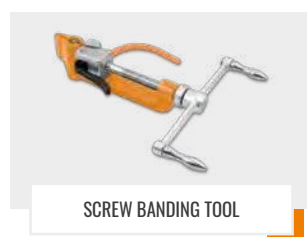

STAINLESS STEEL BANDING BUCKLES

FOR STRAPPING BANDS: STEEL GRADE: AISI 304, 201



Buckle type: **Ear-Lock, L-Type**

Element used to band tensioned stainless steel strapping. Banding buckles are widely used in the power industry, telecommunications, road construction, aviation, military industry, food industry and coal mining. They are made of stainless steel resistant to corrosion, UV radiation and harsh weather conditions. They are also resistant to mechanical factors such as vibrations and high loads. High quality and precise manufacturing of the banding buckles allow for convenient band installation without damage. They work well in urban and industrial environments with moderate pollution. Indoor and outdoor locations exposed to the presence of chlorides. A wide variety of sizes of buckles allows them to be perfectly matched to all types and sizes of our bands.

PRODUCT CHARACTERISTICS:



HIGH STRENGTH AND DURABILITY



RESISTANT TO HIGH AND LOW TEMPERATURES



RESISTANT TO RUPTURE



RESISTANT TO HIGH LOADS



RESISTANT TO VIBRATIONS



MADE OF STAINLESS STEEL



UV-RESISTANT



CORROSION-RESISTANT

TECHNICAL DATA

Width	Thickness	Type	Steel grade	Quantity per pack
19 mm (3/4")	1,5 mm (.059")	Ear-Lock	AISI 304, 201	100 pcs.
16 mm (5/8")	1,5 mm (.059")	Ear-Lock	AISI 304, 201	100 pcs.
	1,0 mm (.039")	Ear-Lock	AISI 304, 201	100 pcs.
12,7 mm (1/2")	1,5 mm (.059")	Ear-Lock	AISI 304, 201	100 pcs.
	1,0 mm (.039")	Ear-Lock	AISI 304, 201	100 pcs.
9,5 mm (3/8")	1,2 mm (.047")	Ear-Lock	AISI 304, 201	100 pcs.
	1,0 mm (.039")	Ear-Lock	AISI 304, 201	100 pcs.
6,4 mm (1/4")	0,8 mm (.031")	L-Type	AISI 304, 201	100 pcs.
20 mm (25/32")	1,0 mm (.039")	L-Type	AISI 304, 201	100 pcs.
10 mm (25/64")	1,0 mm (.039")	L-Type	AISI 304, 201	100 pcs.

*Thickness tolerance +/- 0,1 mm

RELATED PRODUCTS

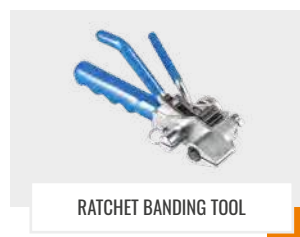
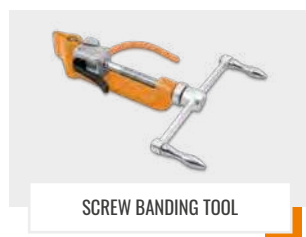
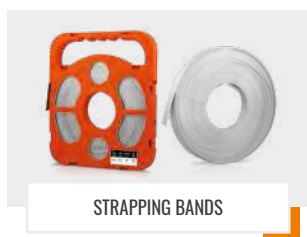

XL STAINLESS STEEL BAND

GRADE 1.4301 / AISI 304



Standard: **EN 10088-2**

Edges: **rounded**

Installation of railroad and tramway power lines, trenchless sewer rehabilitation. Elements used in moderate corrosive environments. Urban and industrial environment with moderate pollution. Indoor and outdoor locations exposed to the presence of chlorides. Chemical and food processing plants, water supply companies. Telecommunication masts and electricity transmission network structures. Coal mining industry in areas exposed to the presence of chlorides. Underground structures, road tunnels, underground infrastructure for the power industry.

MATERIAL CHARACTERISTICS:



CORROSION RESISTANCE IN MODERATE AND MILD ENVIRONMENTS



HIGH MECHANICAL STRENGTH



OPTIMAL COMBINATION OF CORROSION RESISTANCE AND MECHANICAL PROPERTIES



RESISTANT TO OXIDATION AT HIGH TEMPERATURES



RESISTANCE TO LOW TEMPERATURES



SMOOTH FINISH ON ALL SURFACES

TECHNICAL DATA

Width	Thickness	Weight	Steel grade	Length
19,0 mm (3/4")	1,2 mm (.047")	5,5 kg	AISI 304	30 m
	1,0 mm (.039")	4,6 kg	AISI 304	30 m
25,0 mm (1")	1,0 mm (.039")	6,0 kg	AISI 304	30 m
32,0 mm (1 1/4")	1,0 mm (.039")	7,7 kg	AISI 304	30 m

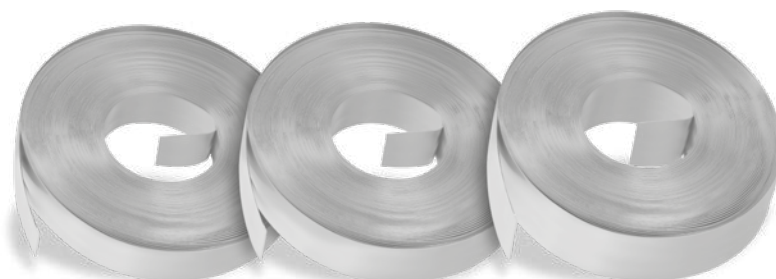



CHEMICAL COMPOSITION

Grade	Element, % (max.)*								
	C	Si	P	S	Mn	Cr	Ni	Mo	N
1.4301	0,07	0,75	0,045	0,015	2,0	17,5 - 19,5	8,0 - 10,5	-	0,1

* Range of the concentrations of elements meeting the requirements of EN 10088-2

MECHANICAL AND ELECTRICAL PROPERTIES

Grade	Mechanical properties *					Electrical properties	
	Tensile strength	Yield strength, min	Elongation, min	Hardness, max		Magnetic permeability	Electrical resistance at 20°C
	R _m , MPa	R _{p0,2} , MPa	A ₈₀ , %	HBW	HRB	μ	Ωxmm ² /m
1.4301	540 - 740	230	45	201	92	1,008	0,73

* Range of the mechanical properties meeting the requirements of EN 10088-2 in saturated state

RELATED PRODUCTS

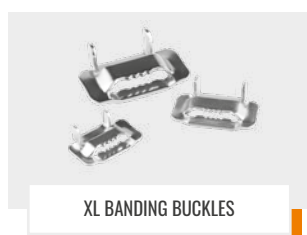

STAINLESS STEEL BANDING BUCKLES

FOR XL STRAPPING BAND; STEEL GRADE: AISI 304



Buckle type: Ear-Lock XL

Element used to band tensioned XL strapping. Banding buckles are widely used in the power industry, telecommunications, road construction, railways, military industry, food industry and coal mining. They are made of stainless steel resistant to corrosion, UV radiation and harsh weather conditions. They are also resistant to mechanical factors such as vibrations and high loads. High quality and precise manufacturing of the banding buckles allow for convenient band installation without damage. They work well in urban and industrial environments with moderate pollution. Indoor and outdoor locations exposed to the presence of chlorides. Designed exclusively for XL type stainless steel strapping bands.

PRODUCT CHARACTERISTICS:



HIGH STRENGTH AND DURABILITY



RESISTANT TO HIGH AND LOW TEMPERATURES



RESISTANT TO RUPTURE



RESISTANT TO HIGH LOADS



RESISTANT TO VIBRATIONS



MADE OF STAINLESS STEEL



UV-RESISTANT



CORROSION-RESISTANT



DESIGNED FOR XL BANDS

TECHNICAL DATA

Width	Thickness	Steel grade	Quantity per pack
19,0 mm (3/4")	2,4 mm (.094")	AISI 304	25 pcs.
25,0 mm (1")	2,4 mm (.094")	AISI 304	25 pcs.
32,0 mm (1 1/4")	2,4 mm (.094")	AISI 304	25 pcs.

* Thickness tolerance +/- 0,1 mm

RELATED PRODUCTS

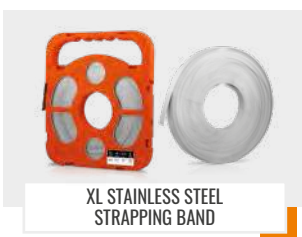



The Loob screw banding tool is used to tension stainless steel bands with width of up to 20 mm in all steel grades offered by Loob. It is made of corrosion-resistant galvanized steel. The tool also has built-in blades for cutting through stainless steel. It is used together with banding buckles. The banding machine is suitable for use in a variety of environments.

USER'S MANUAL

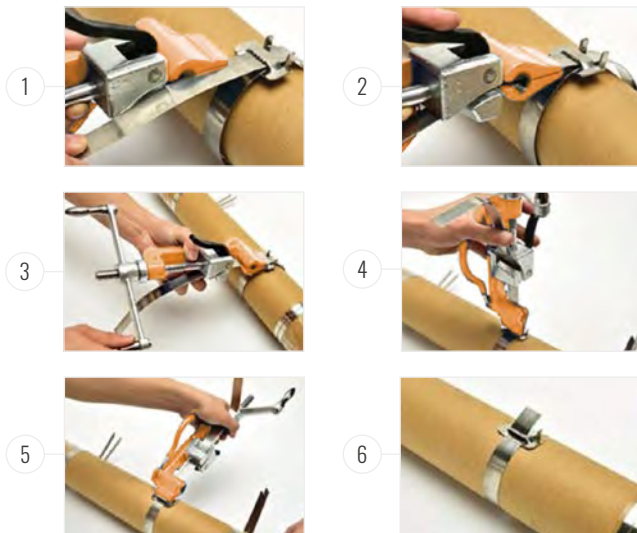

TECHNICAL DATA

Mechanism	Band width range:	Band thickness range:	Dimensions:
Manual	6,4mm-20mm	0,25mm-0,8mm	220x300x60mm

THE BANDING TOOL IS EQUIPPED WITH A REPLACEABLE BLADES SYSTEM AND BEARINGS

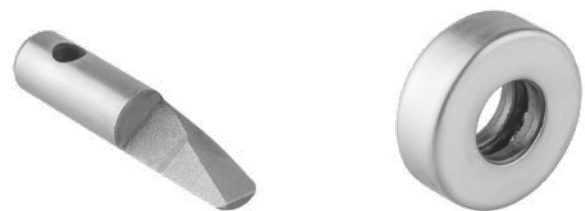

RELATED PRODUCTS

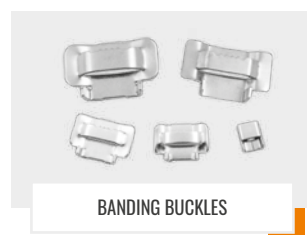
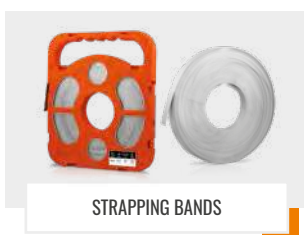



The Common Type Loob ratchet banding tool is designed for working with stainless steel straps of any type, with the width from 6.4 mm to 20 mm used, for example, to install elements on power and telecommunication poles.

It is made of corrosion-resistant galvanized steel with plastic elements.

The tool has a built-in blades system for cutting strapping bands to greatly facilitate installation.

The banding tool is very simple and convenient to use.

TECHNICAL DATA

Mechanism	Band width range:	Band thickness range:
Manual	6,4 mm - 20 mm	0,25 mm - 0,7 mm

RELATED PRODUCTS

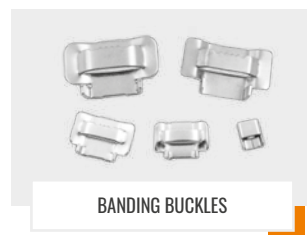
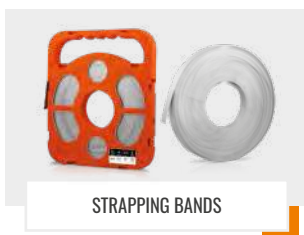

PLASTIC DISPENSER FOR STRAPPING BANDS



Dimensions: **290x250x30 mm**

Weight: **150g**

Material: **plastic**

The Loob plastic dispenser is a convenient and compact item for storing and dispensing Loob stainless steel strapping bands.

The large and convenient dispenser handle allows for comfortable use, the dispenser itself also serves as a protection against mechanical damage to the bands.

PRODUCT CHARACTERISTICS:

 BAND WIDTH RANGE: 20 MM - 6.4 MM

 BAND THICKNESS RANGE: 0.7 MM - 0.4 MM

 LARGE COMFORTABLE HANDLE

 MADE ENTIRELY OF PLASTIC

 ATTRACTIVE DESIGN

 LIGHTWEIGHT

 STURDY BUCKLES

 HIGH QUALITY WORKMANSHIP

PACKAGING CUSTOMIZATION OPTIONS AVAILABLE:

• embossing the distributor's logo on the dispenser



• affixing the distributor's logo by means of a sticker



• change of dispenser colour



RELATED PRODUCTS

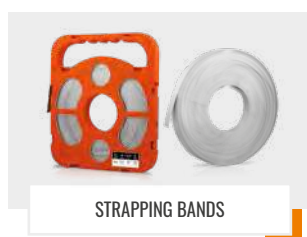

PROTECTIVE RUBBER BAND FOR STEEL STRAPPING



The protective rubber band is an item used to protect delicate components from damage when mounting Loob stainless steel strapping bands on them.

The protective band serves as a sleeve, which is applied on the steel band during installation, thus protecting the components on which the Loob stainless steel strapping band is mounted from damage.

This type of protection is used, for example, on power, lighting and traffic signal poles.

PRODUCT CHARACTERISTICS:



COLOUR: BLACK



DEDICATED BAND WIDTHS: 20MM, 10MM



MADE ENTIRELY OF HIGH QUALITY RUBBER



SIMPLE INSTALLATION



LIGHTWEIGHT



HIGH QUALITY WORKMANSHIP



UV RESISTANT

TECHNICAL DATA

Band width [mm]	Roll length [m]	Weight [kg]
10	10	0,315
20	10	0,660



RELATED PRODUCTS

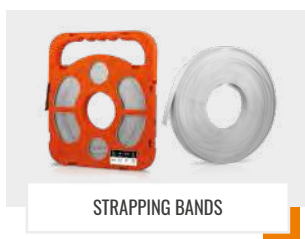

STRAPPING BANDS



STAINLESS STEEL WORM DRIVE CLAMP BAND

STEEL GRADE: AISI 304, AISI 430



This product is used to make your own worm drive hose clamps. This solution enables fabricating a hose clamp of any diameter. Made of stainless steel. Special worm drive buckles are required for complete installation.

The worm drive clamp band has a very wide range of applications such as in automotive workshops or in the hydraulic industry for attaching hoses, ducts and air lines.

High quality materials allows the band to be used in harsh environments.

PRODUCT CHARACTERISTICS:



HIGH STRENGTH AND DURABILITY



RESISTANT TO HIGH AND LOW TEMPERATURES



RESISTANT TO RUPTURE



UV-RESISTANT



CORROSION-RESISTANT



MADE OF STAINLESS STEEL



EASY INSTALLATION

TECHNICAL DATA

Width	Thickness	Steel grade	Roll length	Type of packaging
12 mm	0,6 mm	AISI 304, AISI 430	30 m	Box
9 mm	0,6 mm	AISI 304, AISI 430	30 m	Plastic dispenser

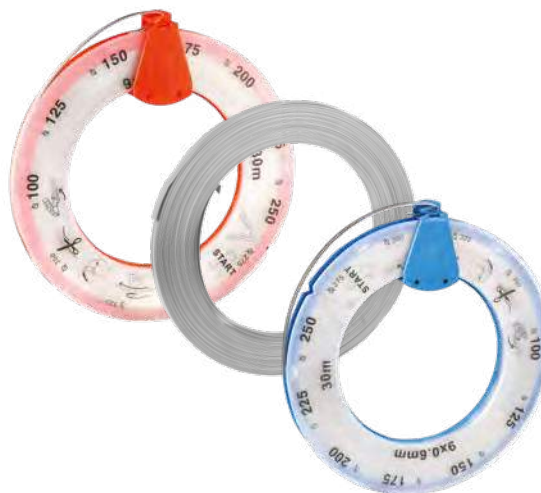

RELATED PRODUCTS

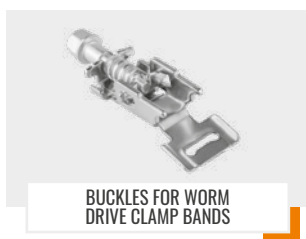

BUCKLES FOR WORM DRIVE CLAMP BANDS



FIXING BUCKLES FOR WORM DRIVE CLAMP BANDS

STEEL GRADE: AISI 304, AISI 430



Buckle type: worm drive

This element is used to conveniently tighten stainless steel worm drive clamp bands with a screwdriver. The buckles are made of high quality stainless steel.

The worm drive mechanism of the buckle allows for precise adjustment of the tension of the hose clamp band.

These buckles are used in many industries – wherever worm drive hose clamps are used, e.g. in car repair shops and hydraulic industry.

PRODUCT CHARACTERISTICS:



HIGH STRENGTH AND DURABILITY



RESISTANT TO HIGH AND LOW TEMPERATURES



RESISTANT TO VIBRATIONS



MADE OF STAINLESS STEEL



UV-RESISTANT



CORROSION-RESISTANT



DESIGNED FOR WORM DRIVE CLAMP BANDS



EASY TO INSTALL

TECHNICAL DATA

Width	Steel grade	Quantity per pack
12 mm	AISI 304, AISI 430	50 pcs.
9 mm	AISI 304, AISI 430	50 pcs.

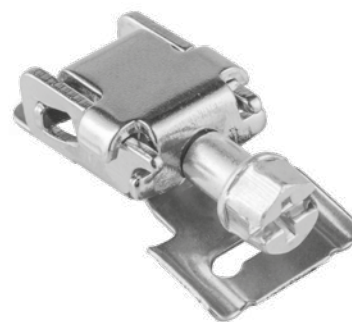

RELATED PRODUCTS



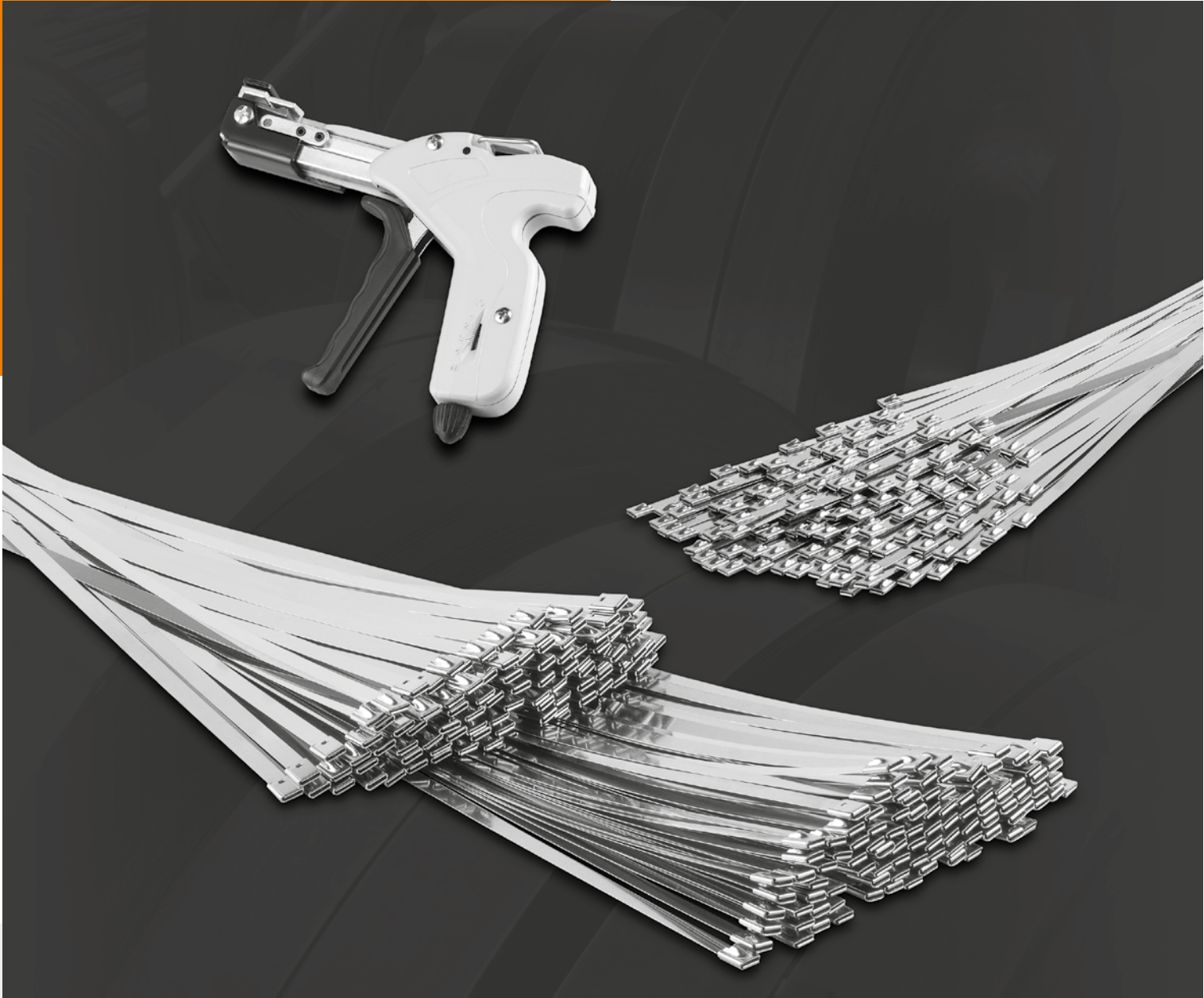

BALL-LOCK CABLE TIES



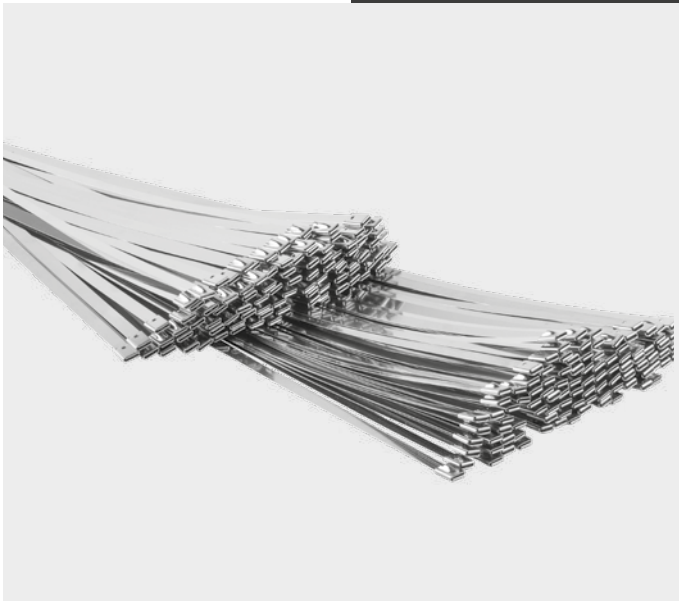

Ball-lock cable ties made of AISI 304 stainless steel, 201 provide excellent resistance to high temperatures, corrosion and extraordinary resistance to UV radiation. These cable ties are very easy to install.

EXAMPLE USE:

- fixing of cables and pipes in shipbuilding, petrochemical plants, offshore platforms and fire risk environments
- „electrical safety” markings in identification label installation (e.g. fire extinguishing system) which must be maintained in the event of fire
- installations where high mechanical and UV resistance is required

The ties can be fastened manually or with a dedicated tool. The ties have rounded edges to increase safety during application and protect against damage to the electrical cable insulation.

TECHNICAL DATA

Material:	AISI 304, 201 stainless steel
Material flammability:	non-flammable
Moisture absorption:	not applicable
Operating temperature:	-80 °C ÷ +538 °C
Resistance:	moderate resistance to acids, seawater, oils, greases, chemicals, solvents. High UV resistance.

SIZE CHART

Steel grade	Length [mm]	Width [mm]	Bundle diameter [mm]	Tensile strength [kg]	Packaging [pcs]
AISI 304, 201	1200	7,9	360	81	100
AISI 304, 201	1050	7,9	310	81	100
AISI 304, 201	750	7,9	191	81	100
AISI 304, 201	600	7,9	154	81	100
AISI 304, 201	400	7,9	102	81	100
AISI 304	300	7,9	76	81	100
AISI 304	200	7,9	50	81	100

Steel grade	Length [mm]	Width [mm]	Bundle diameter [mm]	Tensile strength [kg]	Packaging [pcs]
AISI 304, 201	400	4,5	102	61	100
AISI 304, 201	350	4,5	89	61	100
AISI 304, 201	300	4,5	76	61	100
AISI 304, 201	250	4,5	63	61	100
AISI 304, 201	200	4,5	50	61	100
AISI 304, 201	150	4,5	37	61	100

RELATED PRODUCTS

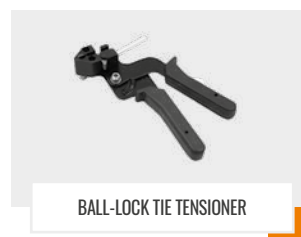
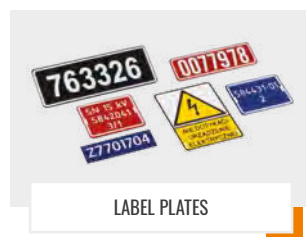
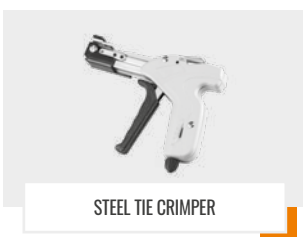

STEEL TIE CRIMPER

BALL-LOCK TYPE



The tool is used to quickly and economically install stainless steel ball-lock cable ties. It automatically cuts ties up to 7.9 mm wide and 0.3 mm thick. It also enables adjusting the tension with a knob located on the bottom of the handle.

This tool is ideal for use in industrial installations, power industry and telecommunications. Allows the tie loop to be tightened and automatically cut off when the required tension is reached.

It is a fast and effective tool with a guarantee of five thousand full tie tightening operations, including cutting.

TECHNICAL DATA

Material:	Dimensions:	Weight:	Max. tie width:	Max. tie thickness:	Tie type:	Guaranteed cycles
metal, plastic	178x140x29 mm	0,56 kg	7,9 mm	0,3 mm	uncoated and coated	5000

RELATED PRODUCTS

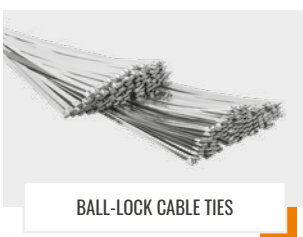



Tool for tensioning and cutting stainless steel cable ties. Resistant to corrosion and oxidation. Ideally suited for Ball-lock ties made from various grades of stainless steel. The handle can be used to adjust the level of tension on the tie as needed, the built-in mechanism cuts off the excess section of the tie.

The tool is very simple and quick to use.

USER'S MANUAL



TECHNICAL DATA

Minimum tie width:	4,6 mm
Maximum tie width:	7,9 mm
Maximum tie thickness:	0,4 mm
Tie type:	uncoated and coated
Mechanism:	manual

RELATED PRODUCTS

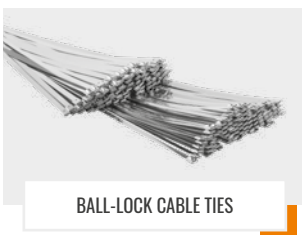



ROAD CONSTRUCTION PRODUCTS



TRAFFIC SIGN HOLDER

TYPE: EDGE



The edge holder is an element used for simple installation of road signs. It is made of galvanized steel. The clamping part of the holder ensures a stable and permanent attachment of the traffic signs.

Two edge holders are required to properly and safely mount one traffic sign.

PRODUCT CHARACTERISTICS:

 MADE OF GALVANIZED STEEL

 EASY INSTALLATION

 HIGH QUALITY WORKMANSHIP

 IMPACT RESISTANT

 CORROSION-RESISTANT

TRAFFIC SIGN HOLDER

TYPE: UNIVERSAL (WAVE)



The universal wave holder is an element used for the simple installation of traffic signs. It is made of galvanized steel. This type of holder is designed for signs with reinforcement (bar or rail) on the back of the sign. The holder is first attached to the sign and then to the post.

Two universal holders are required to properly and securely mount one traffic sign.

PRODUCT CHARACTERISTICS:



MADE OF GALVANIZED STEEL



EASY INSTALLATION



HIGH QUALITY WORKMANSHIP



IMPACT RESISTANT



CORROSION-RESISTANT



DESIGNED FOR SIGNS WITH REINFORCEMENT



AUGER HOLDER FOR EMERGENCY SIGNAGE



The auger holder allows for quick and stable installation of signage markings in soft ground (roadsides, green belts, lawns, pavement after removing cobblestones, etc.).

Replaces concrete and rubber road bases, which are very unwieldy to transport and handle due to their weight and size.

With two stabilizing screws, the auger holder provides stability for installed signs.

It is suitable for 1.5" and 2" traffic sign posts

A special rod for auger installation is included.

PRODUCT CHARACTERISTICS:



MADE OF CARBON STEEL



PROTECTED WITH ANTICORROSIVE PAINT



BLACK



EASY INSTALLATION



HIGH QUALITY WORKMANSHIP



IMPACT RESISTANT



CORROSION-RESISTANT



TWO STABILIZING SCREWS

PRODUCT DIMENSIONS

Overall length:	540 mm
Holding socket length	240 mm
Auger length:	300 mm
Hole diameter:	62 mm

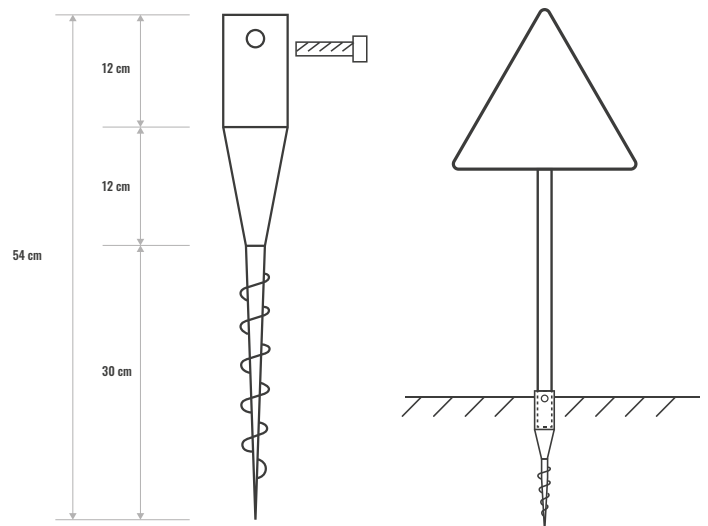

MOUNTING SLEEVE FOR ROAD SIGNS



The mounting sleeve is used to quickly install and remove road signs in places exposed to frequent damage, e.g. as a result of traffic accidents, by turning lorries, intentional damage or in places where signage is often changed.

These sleeves will also be of use in places such as:

- traffic islands
- pedestrian refuges
- bridges
- lane dividers
- in places with changed traffic organization, e.g. cemeteries during All Saints' Day

PRODUCT CHARACTERISTICS:

 MADE OF CAST IRON

 SPECIAL ADAPTER

 HIGH QUALITY WORKMANSHIP

 IMPACT RESISTANT

 CORROSION-RESISTANT

SIGN INSTALLATION IN THE SLEEVE:

The sleeve allows for mounting traffic signs on 1.5" and 2" posts. Place the nut and the clamping insert on the post. Then place the post in the sleeve base and tighten the nut.

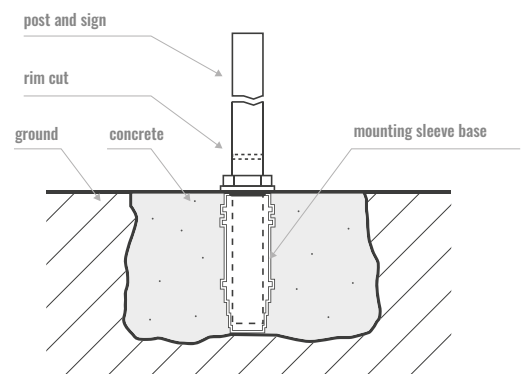
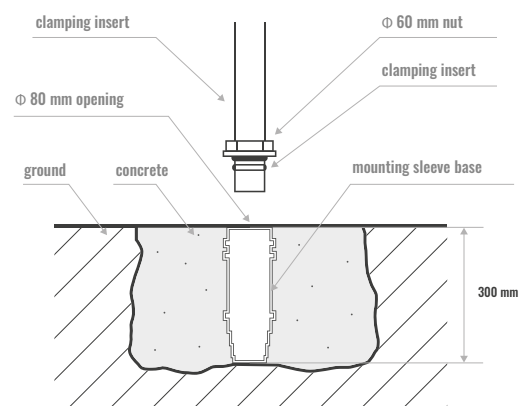

SLEEVE INSTALLATION IN THE GROUND:

For maximum stability and strength, the base of the sleeve should be placed in a previously excavated hole.

The sleeve should then be set upright and the space around the sleeve filled with cement flush with the top edge of the mounting sleeve base.

Remember to protect the sleeve opening from concrete.





POWER INDUSTRY PRODUCTS





Material: aluminium







Information and warning signs and plates for labelling power equipment are made according to the standards of power operators: Enea, Energa, PGE, Tauron and Innogy. The basic content on the plates is embossed.

They are characterized by high durability against weather conditions in Poland. Made of aluminium sheets protected by UV-resistant paint.

We have the ability to emboss any content, according to customer guidelines.

The plates have special mounting holes for 9.5 mm Loob stainless steel bands, 7.9 mm stainless steel Ball-Lock ties or rivets.

PRODUCT CHARACTERISTICS:

-  MADE OF ALUMINIUM
-  RESISTANT TO HIGH AND LOW TEMPERATURES
-  RESISTANT TO VIBRATIONS
-  PROTECTED WITH UV-RESISTANT PAINT
-  UV-RESISTANT
-  CORROSION-RESISTANT
-  EASY TO INSTALL



RELATED PRODUCTS

